

Product Specification

SPECIFICATION FOR APPROVAL

() Preliminary Specification
(?) Final Specification

Title	19.0" SXGA TFT LCD
-------	---------------------------

BUYER	General
MODEL	

SUPPLIER	LG.Philips LCD Co., Ltd.
*MODEL	LM190E05
SUFFIX	SL03

*When you obtain standard approval,
please use the above model name without suffix

SIGNATURE	DATE
/	_____
/	_____
/	_____

Please return 1 copy for your confirmation with your signature and comments.

APPROVED BY	DATE
G.T. Kim / Manager	_____
REVIEWED BY	
K.J. Kwon/ Manager	_____
PREPARED BY	
J.Y.Lee / Engineer	_____

**Product Engineering Dept.
LG. Philips LCD Co., Ltd**

Product Specification

CONTENTS

NO.	ITEM	Page
-	COVER	1
-	CONTENTS	2
-	RECORD OF REVISIONS	3
1	GENERAL DESCRIPTION	4
2	ABSOLUTE MAXIMUM RATINGS	5
3	ELECTRICAL SPECIFICATIONS	6
3-1	ELECTRICAL CHARACTERISTICS	6
3-2	INTERFACE CONNECTIONS	9
3-3	SIGNAL TIMING SPECIFICATIONS	13
3-4	SIGNAL TIMING WAVEFORMS	14
3-5	COLOR INPUT DATA REFERANCE	15
3-6	POWER SEQUENCE	16
4	OPTICAL SPECIFICATIONS	17
5	MECHANICAL CHARACTERISTICS	22
6	RELIABILITY	25
7	INTERNATIONAL STANDARDS	26
7-1	SAFETY	26
7-2	EMC	26
8	PACKING	27
8-1	DESIGNATION OF LOT MARK	27
8-2	PACKING FORM	27
9	PRECAUTIONS	28

Product Specification**RECORD OF REVISIONS**

Revision No	Date	Page	Description
Ver 0.0	Jun. 03. 2005		Preliminary Specifications

Product Specification

1. General Description

The LM190E05-SL03 is a Color Active Matrix Liquid Crystal Display with an integral Cold Cathode Fluorescent Lamp(CCFL) backlight system. The matrix employs a-Si Thin Film Transistor as the active element. It is a transmissive type display operating in the normally black mode. This TFT-LCD has a 19.0 inch diagonal measured active display area with SXGA resolution(1024 vertical by 1280 horizontal pixel array) Each pixel is divided into Red, Green and Blue sub-pixels or dots which are arranged in vertical stripes. Gray scale or the brightness of the sub-pixel color is determined with a 8-bit gray scale signal for each dot, thus, presenting a palette of more than 16.7M colors.

The LM190E05-SL03 has been designed to apply the interface method that enables low power, high speed, low EMI. FPD Link or compatible must be used as a LVDS(Low Voltage Differential Signaling) chip. The LM190E05-SL03 is intended to support applications where thin thickness, wide viewing angle, low power are critical factors and graphic displays are important. In combination with the vertical arrangement of the sub-pixels, the LM190E05-SL03 characteristics provide an excellent flat panel display for office automation products such as monitors.

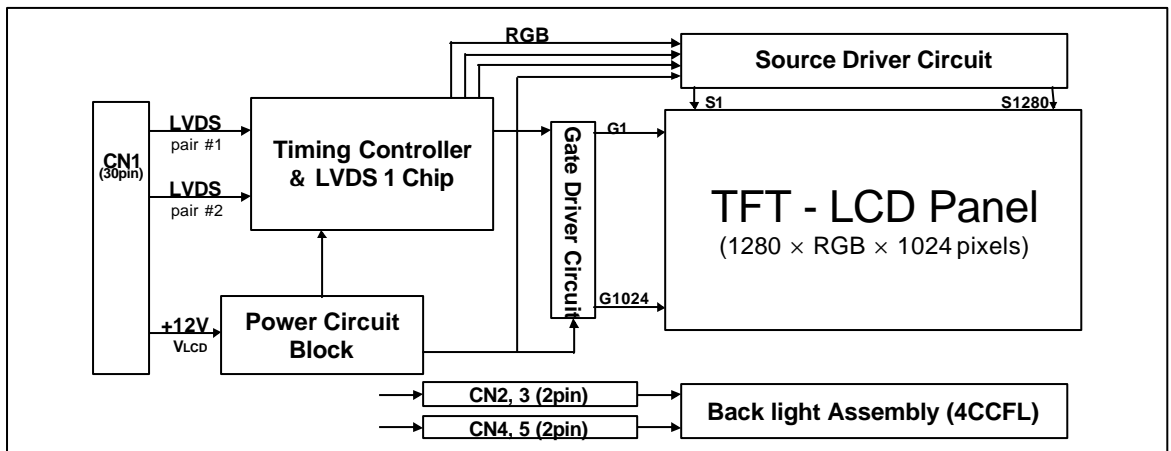

Figure 1. Block diagram

General Features

Active screen size	19.0 inch (481.84mm) diagonal
Outline Dimension	396.0(H) x 324.0(V) x 20.0(D) mm(Typ.)
Pixel Pitch	0.294 xRGB(H)mm x 0.294(V) mm
Pixel Format	1280 horiz. by 1024 vert. Pixels. RGB stripe arrangement
Display Colors	8bit (16.7M colors)
Luminance, white	270 cd/m ² (Typ. Center 1 point)
Viewing Angle (CR>10)	Viewing Angle Free [R/L 178(Typ.), U/D 178(Typ.)]
Power Consumption	Total 25.15 Watt(Typ.), (5.5 Watt @ V _{LCD} , 19.65Watt @[Lamp=7.5mA])
Weight	2,970 g (Typ.)
Display operating mode	Transmissive mode, normally black
Surface treatments	Hard coating (3H), Anti-glare treatment of the front polarizer

Product Specification

2. Absolute maximum ratings

The followings are maximum values which, if exceeded, may cause faulty operation or damage to the unit.

Table 1. Absolute Maximum Ratings

Parameter	Symbol	Values		Units	Notes
		Min.	Max.		
Power Supply Input Voltage	V_{LCD}	- 0.3	+ 14.0	V_{dc}	At 25?
Operating Temperature	T_{OP}	0	+ 50	?	1
Storage Temperature	T_{ST}	- 20	+ 60	?	1
Operating Ambient Humidity	H_{OP}	10	+ 90	%RH	1
Storage Humidity	H_{ST}	10	+ 90	%RH	1

Note : 1. Temperature and relative humidity range are shown in the figure below.
Wet bulb temperature should be 39°C Max, and no condensation of water.

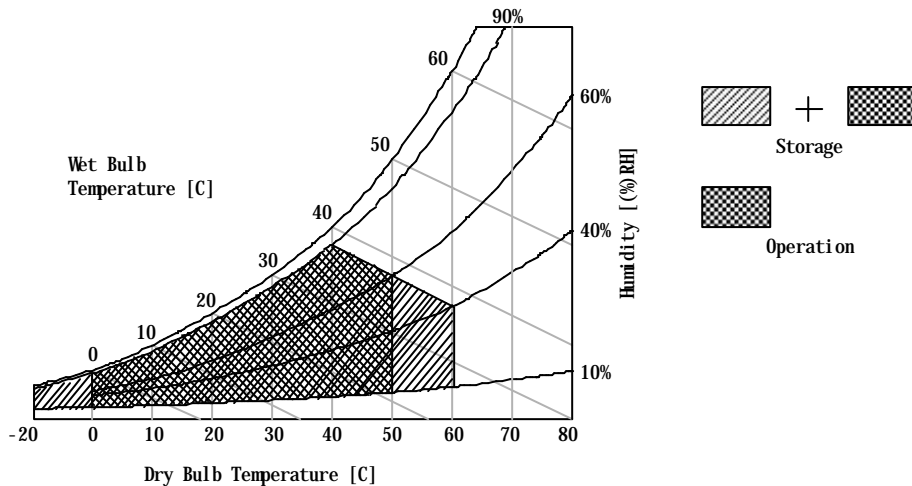

Figure 2. Temperature and relative humidity

Product Specification

3. Electrical specifications

3-1. Electrical characteristics

The LM190E05-SL03 requires two power inputs. One is employed to power the LCD electronics and to drive the TFT array and liquid crystal. Another which powers the CCFL, is typically generated by an inverter. The inverter is an external unit to the LCD.

Table 2. Electrical Characteristics

Parameter	Symbol	Values			Units	Notes
		Min.	Typ.	Max.		
MODULE :						
Power Supply Input Voltage	V_{LCD}	10.8	12.0	13.2	V	
Power Supply Input Current	I_{LCD}	-	0.46	0.53	A	1
	I_{LCD}	-	0.59	0.68	A	2
Differential Impedance	Z_m	90	100	110	ohm	
Power Consumption	P_{LCD}	-	5.5	7.0	Watts	1
Rush Current	I_{RUSH}	-	2.0	3.0	A	3

Notes :

1. The specified current and power consumption are under the $V_{LCD}=12.0V$, $25 \pm 2^\circ C$, $f_v=60Hz$ condition whereas mosaic pattern(8 x 6) is displayed and f_v is the frame frequency.
2. The current is specified at the maximum current pattern.
3. The duration of rush current is about 5ms and rising time of power Input is $500\mu s \pm 20\%$.

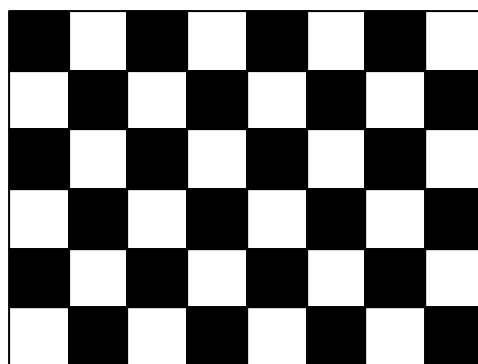

White : 255Gray
Black : 0Gray

[Figure 3] Mosaic pattern (8X6) for power consumption measurement

Product Specification
Table 3. Electrical Characteristics

Parameter	Symbol	Values			Units	Notes
		Min.	Typ.	Max.		
LAMP for each CCFL: Operating Voltage	V_{BL}	645 (@8.0mA)	655 (@7.5mA)	790 (@3.0mA)	V_{RMS}	1,2
Operating Current	I_{BL}	3.0	7.5	8.0	mA_{RMS}	1
Established Starting Voltage	V_{BS}	-	-	1100	V_{RMS}	1,3
at 25 °C		-	-	1400	V_{RMS}	
at 0 °C		-	-	-	V_{RMS}	
Operating Frequency	f_{BL}	40	60	70	KHz	4
Discharge Stabilization Time	T_S	-	-	3	Minutes	1,5
Power Consumption	P_{BL}	-	19.65	21.62	Watts	6
Life Time		40,000	-	-	Hrs	1,7

Notes :

The design of the inverter must have specifications for the lamp in LCD Assembly.

The performance of the Lamp in LCM, for example life time or brightness, is extremely influenced by the characteristics of the DC-AC inverter. So all the parameters of an inverter should be carefully designed so as not to produce too much leakage current from high-voltage output of the inverter.

When you design or order the inverter, please make sure unwanted lighting caused by the mismatch of the lamp and the inverter (no lighting, flicker, etc) never occurs. When you confirm it, the LCD-Assembly should be operated in the same condition as installed in your instrument.

- ? Do not attach a conducting tape to lamp connecting wire. If the lamp wire attach to a conducting tape, TFT-LCD Module has a low luminance and the inverter has abnormal action.
 Because leakage current is occurred between lamp wire and conducting tape.

1. Specified values are for a single lamp.
2. Operating voltage is measured at $25 \pm 2^\circ\text{C}$. The variance of the voltage is $\pm 10\%$.
3. The voltage above V_S should be applied to the lamps for more than 1 second for start-up.
 (Inverter open voltage must be more than lamp starting voltage.)

Otherwise, the lamps may not be turned on. The used lamp current is the lamp typical current.

4. Lamp frequency may produce interface with horizontal synchronous frequency and as a result this may cause beat on the display. Therefore lamp frequency shall be as away possible from the horizontal synchronous frequency and from its harmonics in order to prevent interference.
5. Let's define the brightness of the lamp after being lighted for 5 minutes as 100%.
 T_S is the time required for the brightness of the center of the lamp to be not less than 95%.
6. The lamp power consumption shown above does not include loss of external inverter.
 The used lamp current is the lamp typical current. ($P_{BL} = V_{BL} \times I_{BL} \times N_{Lamp}$)
7. The life is determined as the time at which brightness of the lamp is 50% compared to that of initial value at the typical lamp current on condition of continuous operating at $25 \pm 2^\circ\text{C}$.

Product Specification

Product Specification

3-2. Interface Connections

Interface chip must be used LVDS, part No. SN75LVDS83 (Tx, Texas Instrument) or compatible. This LCD employs a interface connection, a 30 pin connector is used for the module electronics interface. Four 2pin connectors are used for the integral backlight system. The electronics interface connector is a model GT101-30S-H16 (LG Cable) or IN-30-BA 10 (UJU Electronics) which is compatible.

And mating connector is FI-X30H (JAE) or compatible.

The pin configuration for the connector is shown in the table 4 and the signal mapping with LVDS transmitter is shown in the table 5.

Table 4. Module connector pin configuration

Pin No	Symbol	Description
1	RxO0-	LVDS Signal of Odd Channel 0(-)
2	RxO0+	LVDS Signal of Odd Channel 0(+)
3	RxO1-	LVDS Signal of Odd Channel 1(-)
4	RxO1+	LVDS Signal of Odd Channel 1(+)
5	RxO2-	LVDS Signal of Odd Channel 2(-)
6	RxO2+	LVDS Signal of Odd Channel 2(+)
7	GND	Ground
8	RxOC-	LVDS Signal of Odd Channel Clock(-)
9	RxOC+	LVDS Signal of Odd Channel Clock(+)
10	RxO3-	LVDS Signal of Odd Channel 3(-)
11	RxO3+	LVDS Signal of Odd Channel 3(+)
12	RxE0-	LVDS Signal of Even Channel 0(-)
13	RxE0+	LVDS Signal of Even Channel 0(+)
14	GND	Ground
15	RxE1-	LVDS Signal of Even Channel 1(-)
16	RxE1+	LVDS Signal of Even Channel 1(+)
17	GND	Ground
18	RxE2-	LVDS Signal of Even Channel 2(-)
19	RxE2+	LVDS Signal of Even Channel 2(+)
20	RxEC-	LVDS Signal of Even Channel Clock(-)
21	RxEC+	LVDS Signal of Even Channel Clock(+)
22	RxE3-	LVDS Signal of Even Channel 3(-)
23	RxE3+	LVDS Signal of Even Channel 3(+)
24	GND	Ground
25	NC	No connection
26	NC	No connection
27	NC	No connection
28	VCC	Power supply (12.0V Typ.)
29	VCC	Power supply (12.0V Typ.)
30	VCC	Power supply (12.0V Typ.)

First Pixel Data

Second Pixel Data

Product Specification

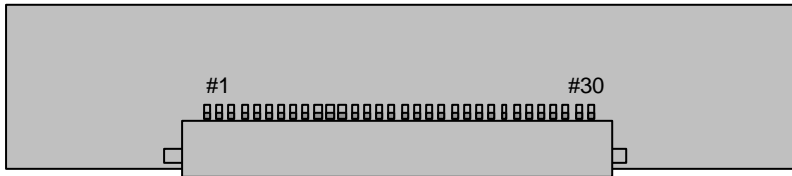

GT101-30S-H16(LGC) or
IN-30-BA 10 (UJU)

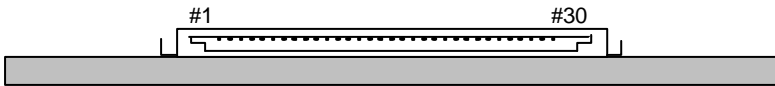

Rear view of LCM

[Figure 4] Connector diagram

- Notes:
1. All GND(ground) pins should be connected together and should also be connected to the LCD's metal frame.
 2. All V_{LCD} (power input) pins should be connected together.
 3. All NC pins should be separated from other signal or power.

Product Specification
Table 5. Required signal assignment for Flat Link (TI:SN75LVDS83) Transmitter

Pin	Pin Name	Require Signal	Pin	Pin Name	Require Signal
1	VCC	Power Supply for TTL Input	29	GND	Ground pin for TTL
2	D5	TTL Input(R7)	30	D26	TTL Input(DE)
3	D6	TTL Input(R5)	31	TxCLKIN	TTL Level clock Input
4	D7	TTL Input(G0)	32	PWR DWN	Power Down Input
5	GND	Ground pin for TTL	33	PLL GND	Ground pin for PLL
6	D8	TTL Input(G1)	34	PLL VCC	Power Supply for PLL
7	D9	TTL Input(G2)	35	PLL GND	Ground pin for PLL
8	D10	TTL Input(G6)	36	LVDS GND	Ground pin for LVDS
9	VCC	Power Supply for TTL Input	37	TxOUT3+	Positive LVDS differential data output3
10	D11	TTL Input(G7)	38	TxOUT3-	Negative LVDS differential data output3
11	D12	TTL Input(G3)	39	TxCLKOUT+	Positive LVDS differential clock output
12	D13	TTL Input(G4)	40	TxCLKOUT -	Negative LVDS differential clock output
13	GND	Ground pin for TTL	41	TxOUT2+	Positive LVDS differential data output2
14	D14	TTL Input(G5)	42	TxOUT2-	Negative LVDS differential data output2
15	D15	TTL Input(B0)	43	LVDS GND	Ground pin for LVDS
16	D16	TTL Input(B6)	44	LVDS VCC	Power Supply for LVDS
17	VCC	Power Supply for TTL Input	45	TxOUT1+	Positive LVDS differential data output1
18	D17	TTL Input(B7)	46	TxOUT1-	Negative LVDS differential data output1
19	D18	TTL Input(B1)	47	TxOUT0+	Positive LVDS differential data output0
20	D19	TTL Input(B2)	48	TxOUT0-	Negative LVDS differential data output0
21	GND	Ground pin for TTL Input	49	LVDS GND	Ground pin for TTL
22	D20	TTL Input(B3)	50	D27	TTL Input(R6)
23	D21	TTL Input(B4)	51	D0	TTL Input(R0)
24	D22	TTL Input(B5)	52	D1	TTL Input(R1)
25	D23	TTL Input(RSVD)	53	GND	Ground pin for TTL
26	VCC	Power Supply for TTL Input	54	D2	TTL Input(R2)
27	D24	TTL Input(HSYNC)	55	D3	TTL Input(R3)
28	D25	TTL Input(VSYNC)	56	D4	TTL Input(R4)

Notes : 1. Refer to LVDS Transmitter Data Sheet for detail descriptions.
2. 7 means MSB and 0 means LSB at R,G,B pixel data

Product Specification

The backlight interface connector is a model BHSR-02VS-1(JST) or 1674817-1(AMP) which is compatible. The mating connector is SM02B-BHSS-1 or equivalent. The pin configuration for the connector is shown in the table below.

Table 6. Backlight connector pin configuration

Pin	Symbol	Description	NOTES
1	HV	High Voltage for Lamp	1
2	LV	Low Voltage for Lamp	2

Notes: 1. The high voltage power terminal is colored gray, sky blue.
2. The low voltage pin color is black, blue.

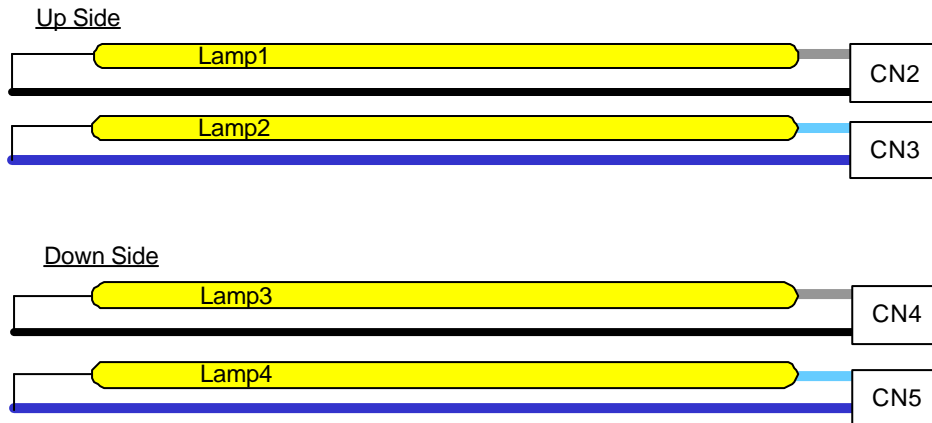

[Figure 5] Backlight connector view

Product Specification

3-3. Signal Timing Specifications

This is the signal timing required at the input of the LVDS Transmitter. All of the interface signal timing should be satisfied with the following specifications for its proper operation.

Table 7. Timing table

Parameter		Symbol	Min.	Typ.	Max.	Unit	Notes
Dclk	Period	tCLK	14.7	18.5	22.2	ns	
	Frequency	fCLK	45.0	54.0	68.4	MHz	
Hsync	Period	tHP	672	844	1022	tCLK	
	Width	tWH	8	56	-		
	Frequency	fH	53.3	64.0	82.1	kHz	
Vsync	Period	tVP	1034	1066	1320	tHP	
	Width	tWV	2	3	24		
	Frequency	fV	47	60	76	Hz	
DE (Data Enable)	Horizontal Valid	tHV	640	640	640	tCLK	
	Horizontal Back Porch	tHBP	8	124	-		
	Horizontal Front Porch	tHFP	8	24	-		
	-	-	-	-	-		
	Vertical Valid	tVV	1024	1024	1024	tHP	
	Vertical Back Porch	tVBP	5	38	124		
	Vertical Front Porch	tVFP	1	1	-		
	-	-	-	-	-		
	DE setup time	tSI	4	-	-	ns	For Dclk
	DE hold time	tHI	4	-	-		
Data	Data setup time	tSD	4	-	-	ns	For Dclk
	Data hold time	tHD	4	-	-		

- Notes : 1. DE mode operation
 2. $tHFP + tWH + tHBP < (1/2) tHV$
 3. The performance of the electro-optical characteristics may be influenced by variance of the vertical refresh rates.
 4. tHFP, tWH and tHBP should be any times of a character number (8).

Product Specification

3-4. Signal Timing Waveforms

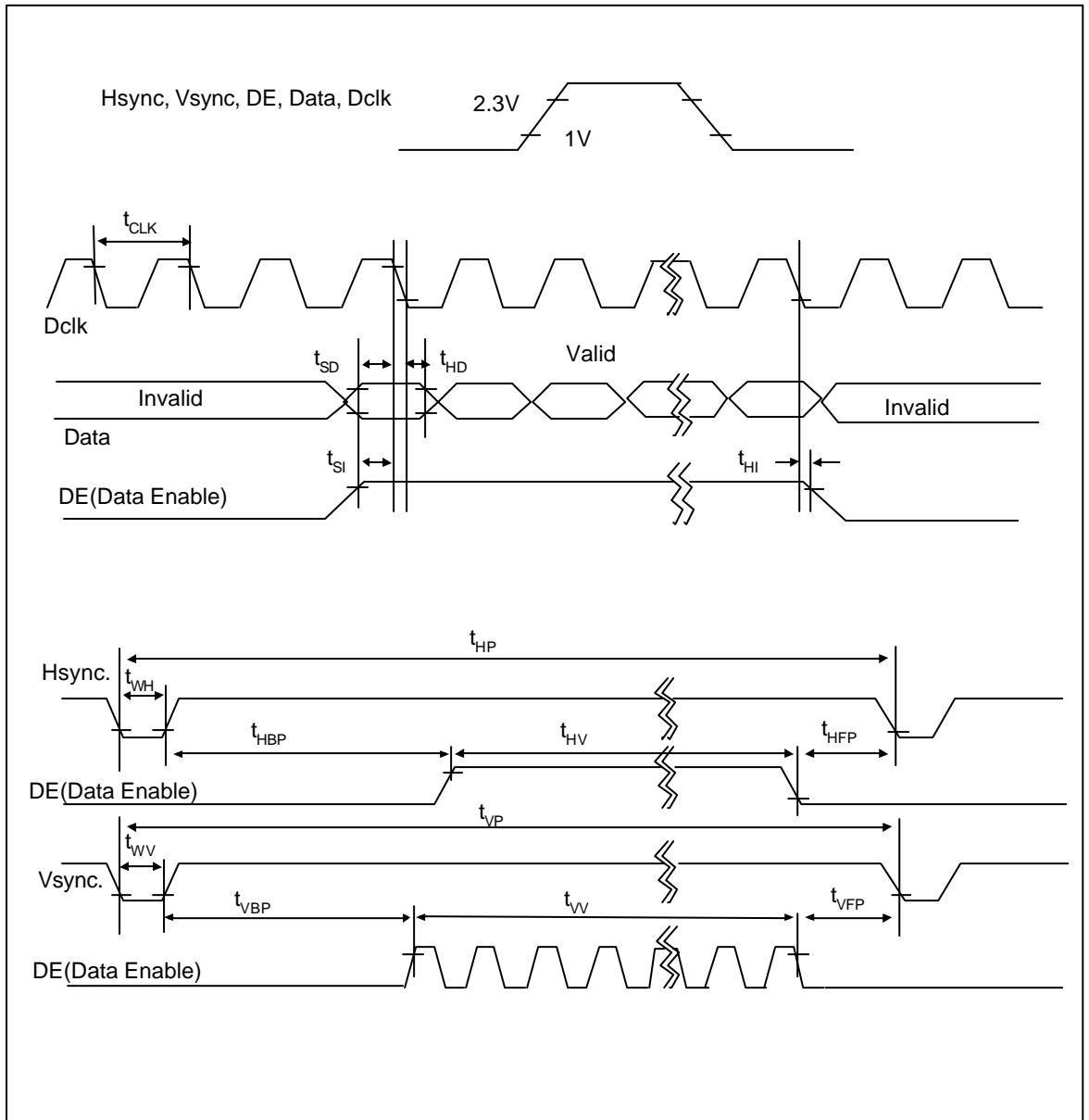

[Figure 6] Signal timing waveforms

Product Specification

3-5. Color Input Data Reference

The brightness of each primary color(red,green and blue) is based on the 8-bit gray scale data input for the color ; the higher the binary input, the brighter the color. The table below provides a reference for color versus data input.

Table 8. Color data reference

Color	Input color data																								
	Red								Green								Blue								
	MSB				LSB				MSB				LSB				MSB				LSB				
	R7	R6	R5	R4	R3	R2	R1	R0	G7	G6	G5	G4	G3	G2	G1	G0	B7	B6	B5	B4	B3	B2	B1	B0	
Basic colors	Black	0	0	0	0	0	0	0	0	0	0	0	0	0	0	0	0	0	0	0	0	0	0	0	
	Red(255)	1	1	1	1	1	1	1	0	0	0	0	0	0	0	0	0	0	0	0	0	0	0	0	
	Green(255)	0	0	0	0	0	0	0	0	1	1	1	1	1	1	1	1	0	0	0	0	0	0	0	
	Blue(255)	0	0	0	0	0	0	0	0	0	0	0	0	0	0	0	0	1	1	1	1	1	1	1	1
	Cyan	0	0	0	0	0	0	0	0	1	1	1	1	1	1	1	1	1	1	1	1	1	1	1	1
	Magenta	1	1	1	1	1	1	1	1	0	0	0	0	0	0	0	0	1	1	1	1	1	1	1	1
	Yellow	1	1	1	1	1	1	1	1	1	1	1	1	1	1	1	1	0	0	0	0	0	0	0	0
	White	1	1	1	1	1	1	1	1	1	1	1	1	1	1	1	1	1	1	1	1	1	1	1	1
Red	Red(000) dark	0	0	0	0	0	0	0	0	0	0	0	0	0	0	0	0	0	0	0	0	0	0	0	
	Red(001)	0	0	0	0	0	0	0	1	0	0	0	0	0	0	0	0	0	0	0	0	0	0	0	
	Red(002)	0	0	0	0	0	0	1	0	0	0	0	0	0	0	0	0	0	0	0	0	0	0	0	
	:	:	:	:	:	:	:	:	:	:	:	:	:	:	:	:	:	:	:	:	:	:	:	:	
	Red(253)	1	1	1	1	1	1	0	1	0	0	0	0	0	0	0	0	0	0	0	0	0	0	0	
	Red(254)	1	1	1	1	1	1	1	0	0	0	0	0	0	0	0	0	0	0	0	0	0	0	0	
	Red(255) bright	1	1	1	1	1	1	1	1	0	0	0	0	0	0	0	0	0	0	0	0	0	0	0	
Green	Green(000)dark	0	0	0	0	0	0	0	0	0	0	0	0	0	0	0	0	0	0	0	0	0	0	0	
	Green(001)	0	0	0	0	0	0	0	0	0	0	0	0	0	0	1	0	0	0	0	0	0	0	0	
	Green(002)	0	0	0	0	0	0	0	0	0	0	0	0	0	1	0	0	0	0	0	0	0	0	0	
	:	:	:	:	:	:	:	:	:	:	:	:	:	:	:	:	:	:	:	:	:	:	:	:	
	Green(253)	0	0	0	0	0	0	0	0	1	1	1	1	1	1	0	1	0	0	0	0	0	0	0	
	Green(254)	0	0	0	0	0	0	0	0	1	1	1	1	1	1	1	0	0	0	0	0	0	0	0	
	Green(255)bright	0	0	0	0	0	0	0	0	1	1	1	1	1	1	1	1	0	0	0	0	0	0	0	
Blue	Blue(000) dark	0	0	0	0	0	0	0	0	0	0	0	0	0	0	0	0	0	0	0	0	0	0	0	
	Blue(001)	0	0	0	0	0	0	0	0	0	0	0	0	0	0	0	0	0	0	0	0	0	0	1	
	Blue(002)	0	0	0	0	0	0	0	0	0	0	0	0	0	0	0	0	0	0	0	0	0	1	0	
	:	:	:	:	:	:	:	:	:	:	:	:	:	:	:	:	:	:	:	:	:	:	:	:	
	Blue(253)	0	0	0	0	0	0	0	0	0	0	0	0	0	0	0	0	1	1	1	1	1	1	0	
	Blue(254)	0	0	0	0	0	0	0	0	0	0	0	0	0	0	0	0	1	1	1	1	1	1	1	
	Blue(255) bright	0	0	0	0	0	0	0	0	0	0	0	0	0	0	0	0	1	1	1	1	1	1	1	

Product Specification

3-6. Power Sequence

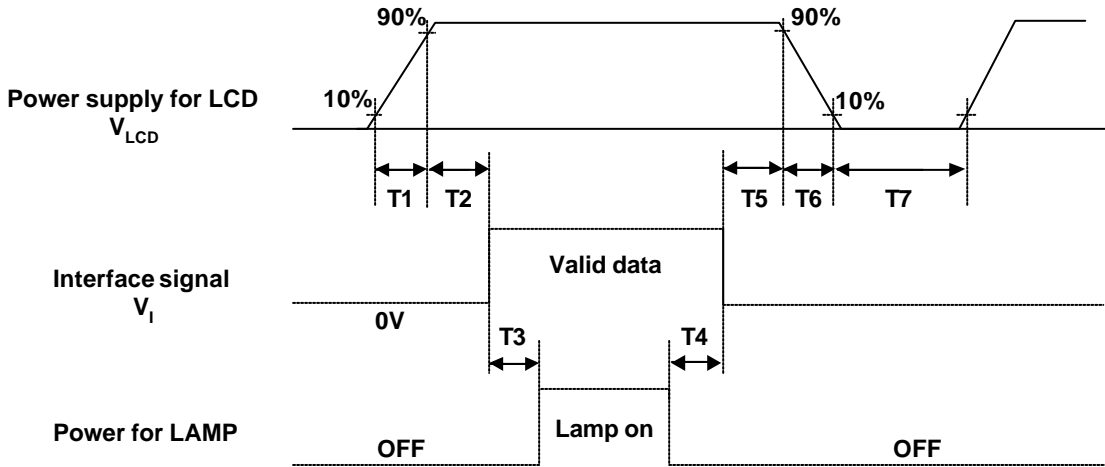

[Figure 7] Power sequence

Table 9. Power sequence time delay

Parameter	Values			Units
	Min.	Typ.	Max.	
T_1	-	-	10	ms
T_2	0.01	-	50	ms
T_3	200	-	-	ms
T_4	150	-	-	ms
T_5	0.01	-	50	ms
T_6	0.01	-	100	ms
T_7	1	-	-	s

- Notes :
1. Please avoid floating state of interface signal at invalid period.
 2. When the interface signal is invalid, be sure to pull down the power supply for LCD V_{LCD} to 0V.
 3. Lamp power must be turn on after power supply for LCD and interface signals are valid.

Product Specification

4. Optical Specifications

Optical characteristics are determined after the unit has been 'ON' and stable for approximately 30 minutes in a dark environment at 25 °C. The values specified are measured at an approximate distance 50cm from the LCD surface at a viewing angle of Φ and θ equal to 0°.

Figure. 9 presents additional information concerning the measurement equipment and method.

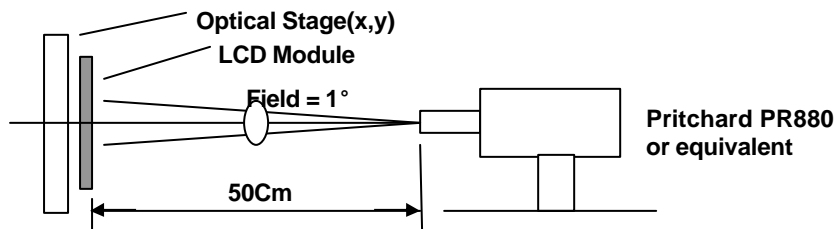

[Figure 9] Optical characteristic measurement equipment and method

Table 10. Optical characteristics (Ta=25 °C, V_{LCD}=12.0V, f_v=60Hz Dclk=54MHz, I_{BL}=7.5mArms)

Parameter	Symbol	Values			Units	Notes	
		Min.	Typ.	Max.			
Contrast ratio	CR	500	800	-		1	
Surface luminance, white	L _{WH}	220	270	-	cd/m ²	2	
Luminance uniformity	δ_{WHITE}	-	-	1.28	%	3	
Response time	Tr	-	18	30	ms	4	
	Rise time Tr _R	-	7	12			
	Decay time Tr _D	-	11	18			
	Gray to Gray	T _{GTG_AVG}	-	14	-	ms	5
		T _{GTG_MAX}	-	22	-		
CIE color coordinates	XR	0.610	0.640	0.670			
	Red	YR	0.314	0.344	0.374		
	Green	XG	0.260	0.290	0.320		
		YG	0.578	0.608	0.638		
	Blue	XB	0.115	0.145	0.175		
		YB	0.044	0.074	0.104		
	White	XW	0.283	0.313	0.343		
YW	0.299	0.329	0.359				
Color Shift	Horizontal	-	178	-	degree	6	
	Vertical						θ_{CST_V}
Viewing angle	General	Horizontal	170	178	-	degree	7
		Vertical					
	Effective	Horizontal	170	178	-	-	8
		Vertical					
Gray scale			-	-		9	

Product Specification

Notes :

1. Contrast ratio(CR) is defined mathematically as :

$$\text{Contrast ratio} = \frac{\text{Surface luminance with all white pixels}}{\text{Surface luminance with all black pixels}}$$
 It is measured at center point.

2. Average Luminance (L_{WH}) is luminance value at location P1 with all pixels displaying white

3. The variation in surface luminance, d_{WHITE} is defined as

$$d_{WHITE} = \frac{\text{Maximum (P1, P2,P3P5)}}{\text{Minimum (P1,P2,P3,..P5)}}$$

Where P1 to P5 are the luminance with all pixels displaying white at 5 locations.

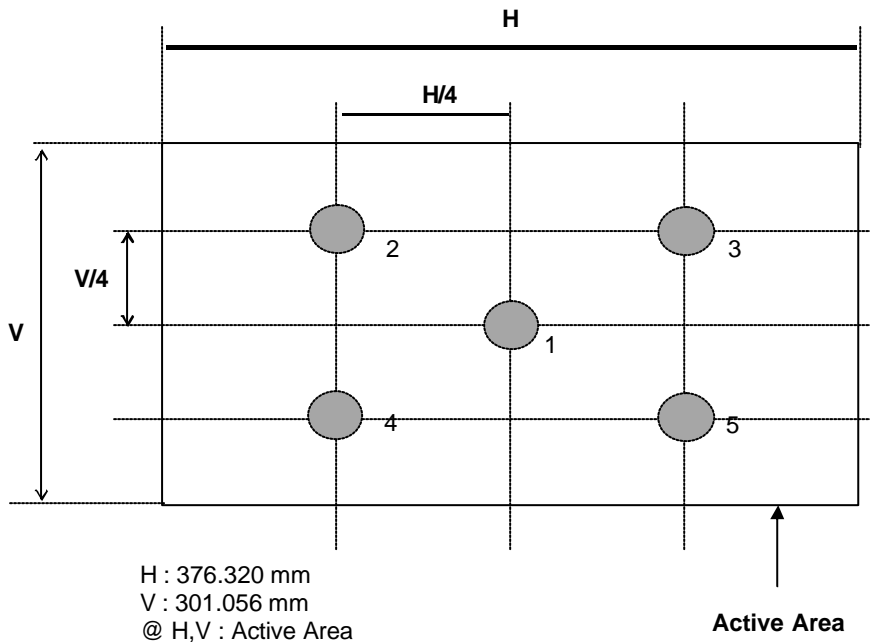

Product Specification

Notes :

4. **The response time** is defined as the following figure and shall be measured by switching the input signal for “black” and “white”.
Response time is the time required for the display to transition from black to white (Rise Time, TrR) and from white to black (Decay Time, TrD).

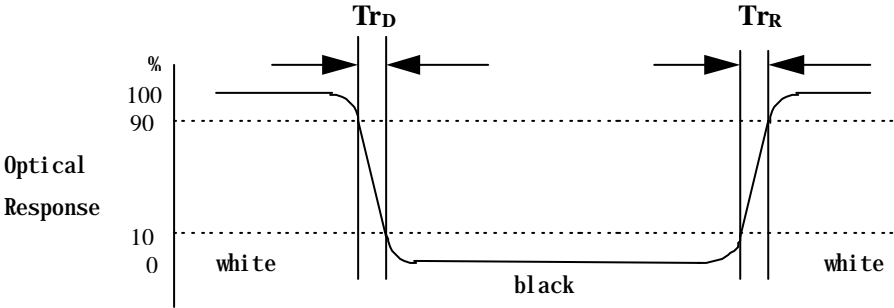

5. **The Gray to Gray response time** is defined as the following figure and shall be measured by switching the input signal for “Gray To Gray “.
- Gray step : 5 Step
 - T_{GTG_AVR} is the total average time at rising time and falling time for “Gray To Gray “.
 - T_{GTG_MAX} is the max time at rising time or falling time for “Gray To Gray “.

Gray to Gray		Rising Time				
		G255	G191	G127	G63	G0
Falling Time	G255					
	G191					
	G127					
	G63					
	G0					

Product Specification

6. **Color shift** is the angle at which the color difference is lower than 0.04.

- Color difference(? u'v')

$$u' = \frac{4x}{-2x + 12y + 3}$$

$$v' = \frac{9y}{-2x + 12y + 3}$$

$$? u'v' = \sqrt{(u'_1 - u'_2)^2 + (v'_1 - v'_2)^2}$$

u'1, v'1 : u'v' value at viewing angle direction

u'2, v'2 : u'v' value at front(? =0)

- Pattern size : 25% Box size

- Viewing angle direction of color shift : Horizontal, Vertical

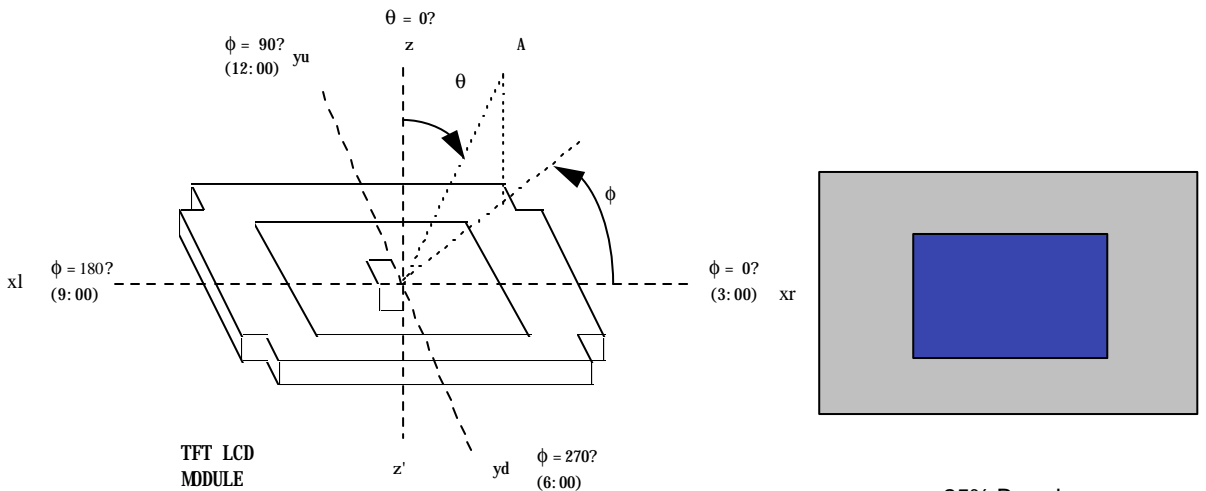

AVERAGE RGB VALUES IN BRUCE RGB FOR MACBETH CHART

	dark skin	light skin	blue sky	follage	blue flower	bluish green
R	98	206	85	77	129	114
G	56	142	112	102	116	199
B	45	123	161	46	185	178
	orange	purplish blue	moderate red	purple	yellow green	orange yellow
R	219	56	211	76	160	230
G	104	69	67	39	193	162
B	24	174	87	86	58	29
	blue	green	red	yellow	magenta	cyan
R	26	72	197	241	207	35
G	32	148	27	212	62	126
B	145	65	37	36	151	172
	white	neutral 8	neutral 6.5	neutral 5	neutral 3.5	black
R	240	206	155	110	63	22
G	240	206	155	110	63	22
B	240	206	155	110	63	22

(Test Pattern : Macbeth Chart)

Product Specification

7. **Viewing angle(general)** is the angle at which the contrast ratio is greater than 10.

8. **Effective viewing angle** is the angle at which the gamma shift of gray scale is lower than 0.3.

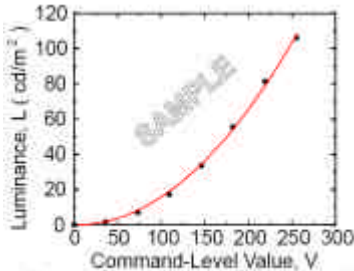

Fig. 1. Sample Luminance vs. gray scale using a 256 bit gray scale.

$$L = aV^r + L_b$$

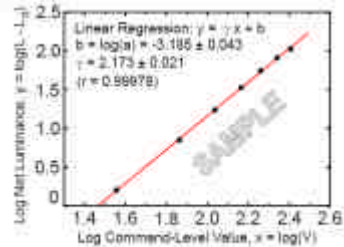

Fig. 2. Sample Log-log plot of luminance vs. gray scale.

$$\log(L - L_b) = r \log(V) + \log(a)$$

Here the Parameter a and r relate the signal level V to the luminance L.

The GAMMA we calculate from the log-log representation (Fig. 2)

9. Grayscale Specification

Gray Level	Relative Luminance [%] (Typ.)
0	0.17
31	1.41
63	5.59
95	14.2
127	24.7
159	38.4
191	55.3
223	78.9
255	100

Product Specification

5. Mechanical Characteristics

Table 11. provides general mechanical characteristics for the model LM190E05-SL03. Please refer to Figure 15,16 regarding the detailed mechanical drawing of the LCD.

Table 12. Mechanical characteristics

Outside dimensions	Horizontal	396.0 ± 0.5mm
	Vertical	324.0 ± 0.5mm
	Depth	20.0 ± 0.5mm
Bezel area	Horizontal	380.3 ± 0.5mm
	Vertical	305.0 ± 0.5mm
Active display area	Horizontal	376.32mm
	Vertical	301.06mm
Weight(approximate)	2,970g(Typ.), 3,120g(Max.)	
Surface Treatment	Hard coating(3H) Anti-glare treatment of the front polarizer	

Product Specification

Figure 15. Front view

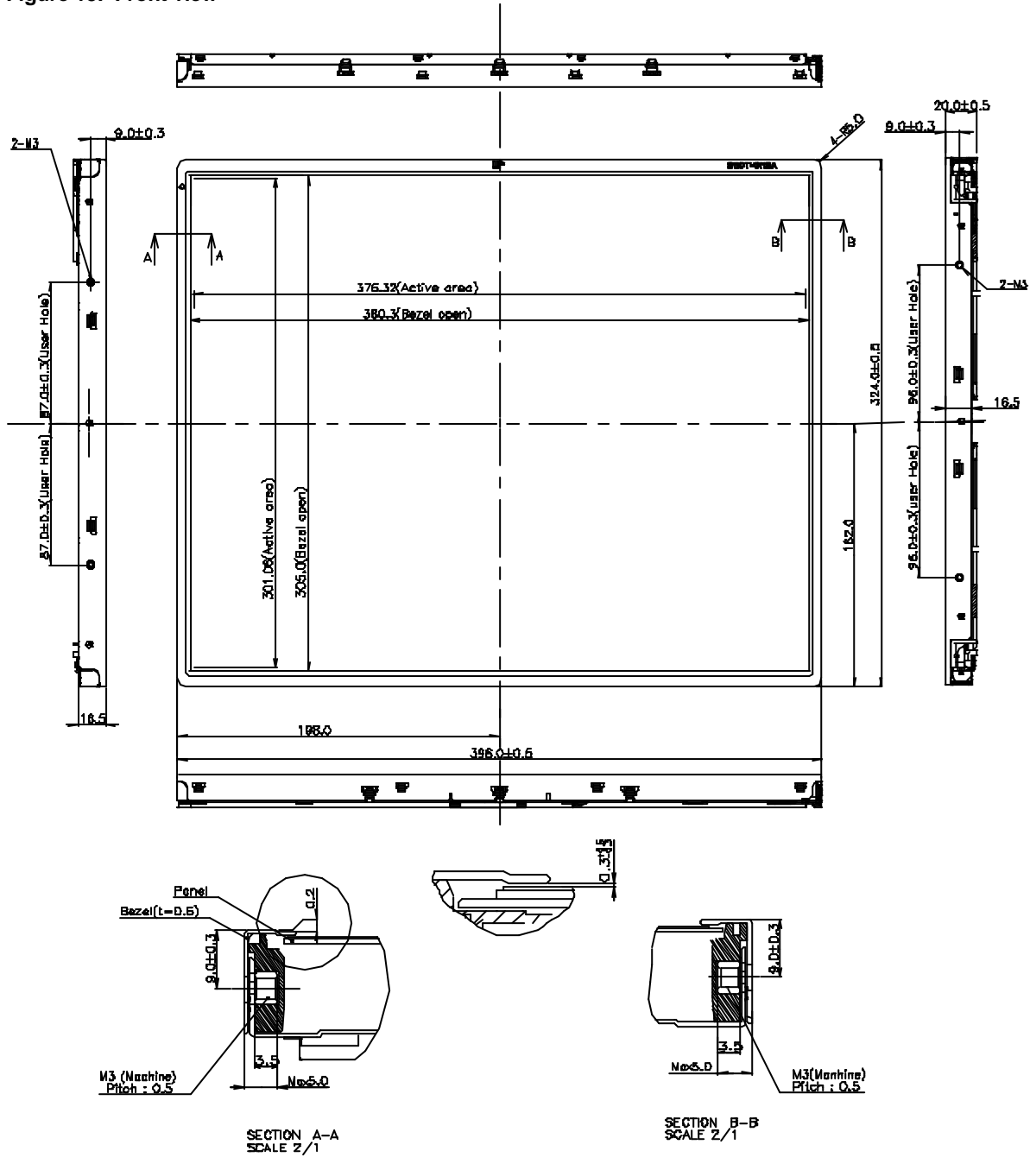

Product Specification

Figure 15. Rear view

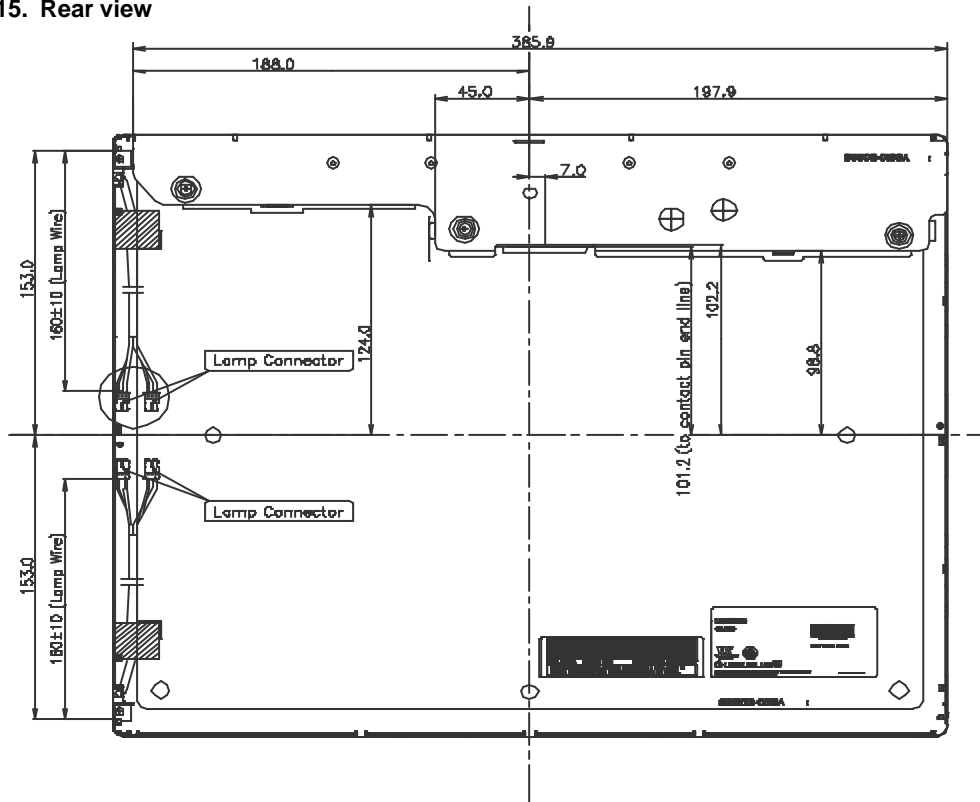

- Notes
1. Backlight : 4 Cold Cathode Fluorescent Lamps
 2. I/F Connector Specification : GT1 01-30S-H1B(LGC)/IN-30-BA 10(LJU)
 3. Lamp Connector Specification - BHSR-02VS-1(JST) or Compatible
 4. Torque of user hole : 3.0~4.0kgf-cm
 5. Tilt and partial disposition tolerance of display area as following
 - (1) Y-Direction : IA-BI <= 1.0
 - (2) X-Direction : IC-DI <= 1.0

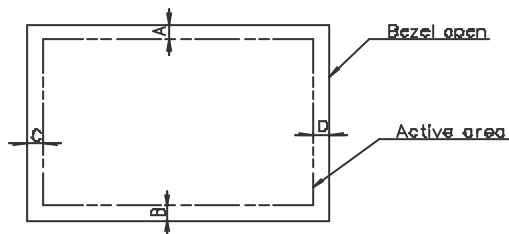

8. Lamp(CCFL) No. is marked at back light connector

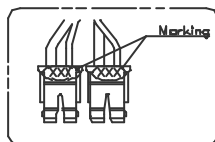

9. Do not wind conductive tape around the backlight wires
10. Unspecified tolerances to be ± 0.5mm

Product Specification

6. Reliability

Table 12. Environment test condition

No.	Test item	Conditions
1	High temperature storage test	Ta= 60°C 240h
2	Low temperature storage test	Ta= -20°C 240h
3	High temperature operation test	Ta= 50°C 50%RH 240h
4	Low temperature operation test	Ta= 0°C 240h
5	Vibration test (non-operating)	5 to 200 Hz (Random Wave) 14.406 (m/s ²) rms Test Time & Vibration Direction 33 min X 3 Axis(X, Y, Z-direction) = 99 min
6	Shock test (non-operating)	Shock level : 100G Waveform : half sine wave, 2ms Direction : ± X, ± Y, ± Z One time each direction
7	Altitude storage / shipment operation	0 - 40,000 feet(12,192m) 0 - 10,000 feet(3,048m)

{ Result evaluation criteria }

There should be no change which might affect the practical display function when the display quality test is conducted under normal operating condition.

Product Specification

7. International Standards

7-1. Safety

- a) UL 60950, Third Edition, Underwriters Laboratories, Inc., Dated Dec. 11, 2000.
Standard for Safety of Information Technology Equipment, Including Electrical Business Equipment.
- b) CAN/CSA C22.2, No. 60950, Third Edition, Canadian Standards Association, Dec. 1, 2000.
Standard for Safety of Information Technology Equipment, Including Electrical Business Equipment.
- c) EN 60950 : 2000, Third Edition
IEC 60950 : 1999, Third Edition
European Committee for Electrotechnical Standardization(CENELEC)
EUROPEAN STANDARD for Safety of Information Technology Equipment Including Electrical Business Equipment.

7-2. EMC

- a) ANSI C63.4 "Methods of Measurement of Radio-Noise Emissions from Low-Voltage Electrical and Electrical Equipment in the Range of 9kHz to 40GHz." American National Standards Institute(ANSI), 1992
- b) C.I.S.P.R "Limits and Methods of Measurement of Radio Interface Characteristics of Information Technology Equipment." International Special Committee on Radio Interference.
- c) EN 55022 "Limits and Methods of Measurement of Radio Interface Characteristics of Information Technology Equipment." European Committee for Electrotechnical Standardization.(CENELEC), 1998 (Including A1: 2000)

Notes : The LM190E05-SL03 is applied ROHS

Product Specification

8. Packing

8-1. Designation of Lot Mark

a) Lot Mark



A,B,C : SIZE(INCH)

E : MONTH

G : ASSEMBLY CODE

D : YEAR

F : FACTORY CODE

H ~ M : SERIAL NO.

Note

1. YEAR

Year	2001	2002	2003	2004	2005	2006	2007	2008	2009	2010
Mark	1	2	3	4	5	6	7	8	9	0

2. MONTH

Month	Jan	Feb	Mar	Apr	May	Jun	Jul	Aug	Sep	Oct	Nov	Dec
Mark	1	2	3	4	5	6	7	8	9	A	B	C

3. FACTORY CODE

Factory Code	LPL Gumi	LPL Nanjing	HEESUNG
Mark	K	C	D

4. SERIAL NO.

Mark	100001~199999, 200001~299999, 300001~399999,, A00001~A99999,, Z00001~Z99999
------	---

b) Location of Lot Mark

Serial No. is printed on the label. The label is attached to the backside of the LCD module.
This is subject to change without prior notice.

8-2. Packing Form

a) Package quantity in one box : 6 pcs

b) Box size : 533mm X 310mm X 459mm.

Product Specification

9. Precautions

Please pay attention to the following when you use this TFT LCD module.

9-1. Mounting Precautions

- (1) You must mount a module using holes arranged in four corners or four sides.
- (2) You should consider the mounting structure so that uneven force (ex. twisted stress) is not applied to the module.
And the case on which a module is mounted should have sufficient strength so that external force is not transmitted directly to the module.
- (3) Please attach a transparent protective plate to the surface in order to protect the polarizer.
Transparent protective plate should have sufficient strength in order to resist external force.
- (4) You should adopt a mounting structure to satisfy the temperature specification.
- (5) Acetic acid type and chlorine type materials for the cover case are not described because the former generates corrosive gas by attacking the polarizer at high temperature and the latter causes circuit break by electro-chemical reaction.
- (6) Do not touch, push or rub the exposed polarizers with glass, tweezers or anything harder than HB pencil lead. And please do not rub with dust cloths with chemical treatment.
Do not touch the surface of polarizer for bare hand or greasy cloth. (Some cosmetics are determined to be harmful to the polarizer.)
- (7) When the surface becomes dusty, please wipe gently with absorbent cotton or other soft materials like chamois soaked with petroleum benzene. Normal hexane is recommended for cleaning the adhesives used to attach front / rear polarizers. Do not use acetone, toluene and alcohol because they cause chemical damage to the polarizer.
- (8) Wipe off saliva or water drops as soon as possible. Their long time contact with polarizer causes deformations and color fading.
- (9) Do not open the case because inside circuits do not have sufficient strength.

9-2. Operating Precautions

- (1) The spike noise causes the mis-operation of circuits. It should be lower than following voltage:
 $V = \pm 200\text{mV}$ (Over and under shoot voltage)
- (2) Response time depends on the temperature. (In lower temperature, it becomes longer.)
- (3) Brightness depends on the temperature. (In lower temperature, it becomes lower.)
And in lower temperature, response time (required time that brightness is stable after turned on) becomes longer.
- (4) Be careful for condensation at sudden temperature change. Condensation makes damage to polarizer or electrical contacted parts. And after fading condensation, smear or spot will occur.
- (5) When fixed patterns are displayed for a long time, remnant image is likely to occur.
- (6) Module has high frequency circuits. Sufficient suppression to the electromagnetic interference shall be done by system manufacturers. Grounding and shielding methods may be important to minimize the interference.
- (7) Please do not give any mechanical and/or acoustical impact to LCM. Otherwise, LCM can not be operated its full characteristics perfectly.
- (8) A screw which is fastened up the steel should be a machine screw (if not, it causes metal foreign material and deal LCM a fatal blow)
- (9) Please do not set LCD on its edge.

Product Specification

9-3. Electrostatic Discharge Control

Since a module is composed of electronic circuits, it is not strong to electrostatic discharge. Make certain that treatment persons are connected to ground through wrist bard etc. And don't touch interface pin directly.

9-4. Precautions for Strong Light Exposure

Strong light exposure causes degradation of polarizer and colorfilter.

9-5. Storage

When storing modules as spares for a long time, the following precautions are necessary.

- (1) Store them in a dark place. Do not expose the module to sunlight or fluorescent light. Keep the temperature between 5°C and 35°C at normal humidity.
- (2) The polarizer surface should not come in contact with any other object.
It is recommended that they be stored in the container in which they were shipped.

9-6. Handling Precautions for Protection Film

- (1) The protection film is attached to the bezel with a small masking tape.
When the protection film is peeled off, static electricity is generated between the film and polarizer. This should be peeled off slowly and carefully by people who are electrically grounded and with well ion-blown equipment or in such a condition, etc.
- (2) When the module with protection film attached is stored for a long time, sometimes there remains a very small amount of glue still on the Bezel after the protection film is peeled off.
- (3) You can remove the glue easily. When the glue remains on the Bezel or its vestige is recognized, please wipe them off with absorbent cotton waste or other soft material like chamois soaked with normal-hexane.